

PV Grid Tie Inverter

Solis Three Phase Inverter

Installation and Operation Manual



Contents

1. Introduction	3
1.1 Introductions	3
1.2 Packaging	4
2. Safety Instructions	5
2.1 Safety Symbols	5
2.2 General Safety Instructions	5
2.3 Notice For Use	6
3. Overview	7
3.1 Front Panel Display	7
3.2 LED Status Indicator Lights	7
3.3 Keypad	8
3.4 LCD	8
4. Installation	9
4.1 Selecting Location for the Inverter	9
4.2 Mounting the Inverter	11
4.3 Electrical Connections	12
5. Start and Stop	18
5.1 Start the Inverter	19
5.2 Stop the Inverter	19

Contents

6. Operation	20
6.1 Main Menu	20
6.2 Information	20
6.3 Settings	22
6.3.1 Set Time	22
6.3.2 Set Address	22
6.4 Advanced Info.	23
6.4.1 Alarm Message	23
6.4.2 Temperature	23
6.4.3 Standard No.	24
6.4.4 Version	24
6.4.5 Communication Data	24
6.5 Advanced Settings	24
6.5.1 Selecting Standard	25
6.5.2 Grid ON/OFF	27
6.5.3 Calibrate Energy	27
7. Maintenance	28
8. Trouble Shooting	28
9. Specifications	30

1. Introduction

Solis three phase series PV inverters could transfer DC power from PV panels into AC power and feed into grid. There are 6 models for Solis three phase inverter.

Solis-6K, Solis-10K, Solis-15K are used for 380/400V three phase grid system, Solis-20K-HV is used for 480V three phase grid system.

Solis-6K-LV, Solis-10K-LV are use for 208/220/240V three phase grid system.

All 6 models are transformerless topology grid tie PV inverter.



▲ Figure 1.1 Front side view

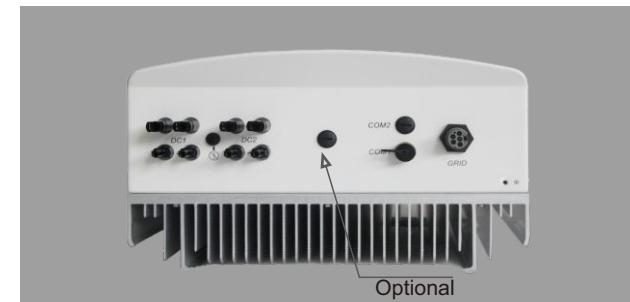

▲ Figure 1.2 Bottom side view

1. Introduction

1.2 Packaging

When you receive the inverter, please check if all the parts listed below are included:



Part NO.	Description	Number
1	PV grid tie inverter	1
2	Wall mounting bracket	1
3	Locking screws	2
5	AC connector	1
6	DC connectors	4 pairs(2 for Solis-6K)
7	Manual	1

▲ Table 1.1 Material list

2. Safety Instructions

Improper use may result in potential electric shock hazards or burns. This manual contains important instructions that should be followed during installation and maintenance. Please read these instructions carefully before use and keep them for future reference.

2.1 Safety Symbols

Safety symbols used in this manual, which highlight potential safety risks and important safety information, are listed as follows:



WARNING:

WARNING symbol indicates important safety instructions, which if not correctly followed, could result in serious injury or death.



NOTE:

NOTE symbol indicates important safety instructions, which if not correctly followed, could result in some damage or the destruction of the inverter.



CAUTION:

CAUTION, RISK OF ELECTRIC SHOCK symbol indicates important safety instructions, which if not correctly followed, could result in electric shock.



CAUTION:

CAUTION, HOT SURFACE symbol indicates safety instructions, which if not correctly followed, could result in burns.

2.2 General Safety Instructions



WARNING:

Please don't connect PV array positive(+) or negative(-) to the ground, it could cause serious damage to the inverter.



WARNING:

Electrical installations must be done in accordance with the local and national electrical safety standards

2. Safety Instructions



WARNING:

To reduce the risk of fire, branch-circuit over-current protective devices (OCPD) are required for circuits connected to the Inverter. The recommend rated trip current for AC breaker should be 25A for Solis-6K inverter, 32A for Solis-10K, Solis-15K, Solis-20K-HV inverter.



CAUTION:

Risk of electric shock. Do not remove cover. There is no user serviceable parts inside. Refer servicing to qualified and accredited service technician.



CAUTION:

The PV array (Solar panels) supplies a DC voltage when it is exposed to light.



CAUTION:

Risk of electric shock from energy stored in capacitors of the Inverter. Do not remove cover until 5 minutes after disconnecting all sources of supply. Service technician only. Warranty may be voided if any unauthorized removal of cover.



CAUTION:

The surface temperature of the inverter can reach up to 75°C (167 F). To avoid risk of burns, do not touch the surface when inverter is operating. Inverter must be installed out the reach of children.

2.3 Notice For Use

The inverter has been constructed according to the applicable safety and technical guidelines. Use the inverter in installations that meet the following specification ONLY:

1. Permanent installation is required.
2. The inverter must be connected to a separate grounded AC group, to which no other electrical equipment is connected.
3. The electrical installation must meet all the applicable regulations and standards.
4. The inverter must be installed according to the instructions stated in this manual.
5. The inverter must be installed according to the correct technical specifications.
6. To startup the inverter, the Grid Supply Main Switch (AC) must be switched on, before the solar panel's DC isolator shall be switched on. To stop the inverter, the Grid Supply Main Switch (AC) must be switched off before the solar panel's DC isolator shall be switched off.

3. Overview

3.1 Front Panel Display

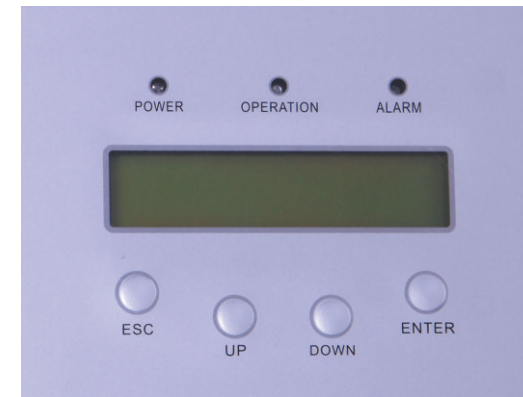

▲ Figure 3.1 Front Panel Display

3.2 LED Status Indicator Lights

There are three LED status indicator lights in the front panel of the inverter. Left LED: POWER LED (red) indicates the power status of the inverter. Middle LED: OPERATION LED (green) indicates the operation status. Right LED: ALARM LED (yellow) indicates the alarm status. Please see Table 3.1 for details

Light	Status	Description
● POWER	ON	The inverter can detect DC power
	OFF	No DC power or low DC power
● OPERATION	ON	The inverter is operating properly.
	OFF	The inverter has stopped to supply power.
	FLASHING	The inverter is initializing.
● ALARM	ON	Alarm or fault condition is detected.
	OFF	The inverter is operating properly.

▲ Table 3.1 Status Indicator Lights

3. Overview

3.3 Keypad

There are four keys in the front panel of the Inverter(from left to right): ESC, UP, DOWN and ENTER keys. The keypad is used for:

- Scrolling through the displayed options (the UP and DOWN keys);
- Access to modify the adjustable settings (the ESC and ENTER keys).

3.4 LCD

The two-line Liquid Crystal Display (LCD) is located at the front panel of the Inverter, which shows the following information:

- Inverter operation status and data;
- Service messages for operator;
- Alarm messages and fault indications.

4. Installation

4.1 Select a Location for the Inverter

To select a location for the inverter, the following criteria should be considered:

- Do not install in small closed spaces where air cannot circulate freely. To avoid overheating, always make sure the flow of air around the inverter is not blocked.
- Exposure to direct sunlight will increase the operational temperature of the inverter and may cause output power limiting. Ginlong recommend inverter installed to avoid direct sunlight or raining.
- To avoid over heating ambient air temperature **MUST** be considered when choosing the inverter installation location. Ginlong recommend using a sun shade minimizing direct sunlight when the ambient air temperature around the unit exceeds 40°C.

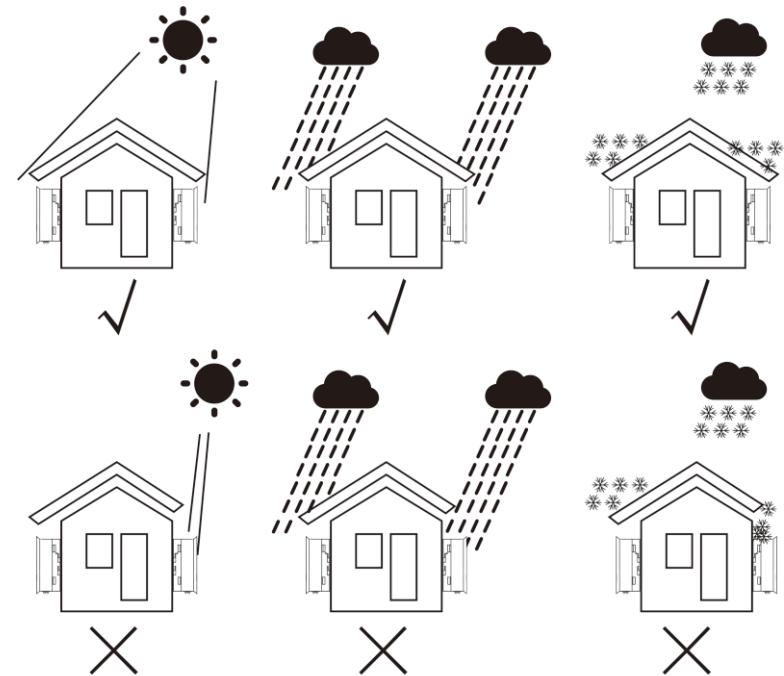

▲ Figure 4.1 Recommend Installation place

4. Installation

- Install on a wall or strong structure capable of bearing the weight.
- Install vertically with a maximum incline of +/- 5°. If the mounted inverter is tilted to an angle greater than the maximum noted, heat dissipation can be inhibited, and may result in less than expected output power.
- For 1 or more inverter installed, a minimum 12in clearance should be kept between each inverter or other object. The bottom of the inverter should be 20in clearance to the ground.

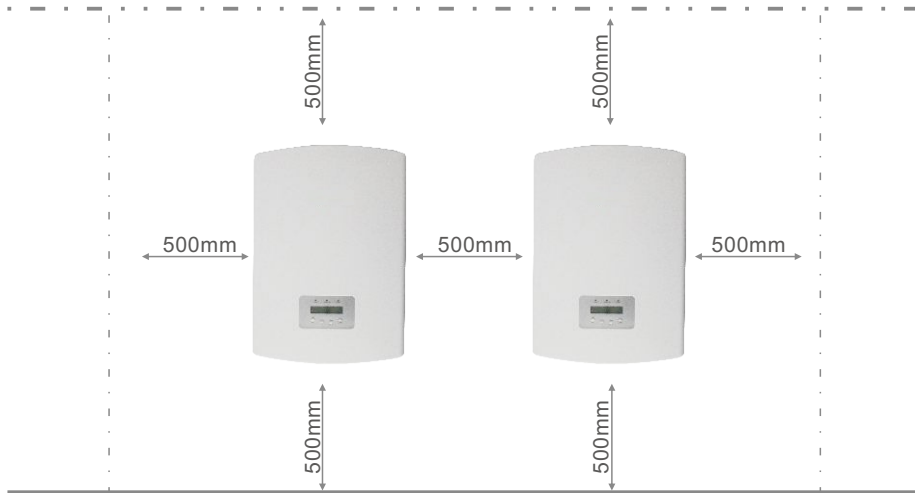

▲ Figure 4.2 Inverter Mounting clearance

- Visibility of the LED status indicator lights and the LCD located at the front panel of the inverter should be considered.
- Adequate ventilation must be provided if the inverter is to be installed in a confined space.



NOTE:

Nothing should be stored on or placed against the inverter.

4. Installation

4.2 Mounting the Inverter

Please use suitable fixings for wall type (e.g. use dynabolts for brick, masonry, etc).

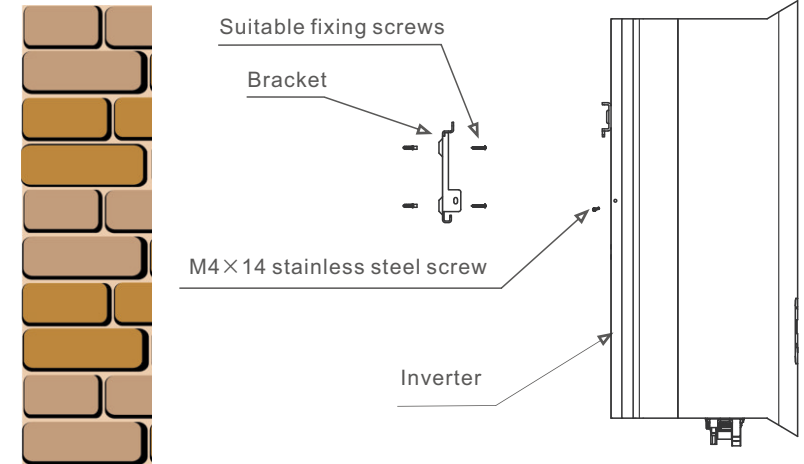

▲ Figure 4.3 Inverter Mounting

Inverter should be mounted in a vertical position as shown in Figure 4.3. The steps to mount the inverter on the wall are given as follows:

1. Locate the wall studs in the desired location and align the wall mount bracket over the studs. Mark the mounting holes. For masonry walls, the mounting holes should be for a suitable dynabolt type mounting system.
2. MAKE SURE BRACKET IS horizontal. Ensure that the A, B, C, and D mounting holes (in Figure 4.3) are aligned with the wall's most secure points (e.g. wall studs in case of clad building materials).



WARNING:

Bracket must be mounted vertically on a vertical wall surface.

4. Installation

- Carefully hang the inverter on the upper part of the wall mount bracket by fitting the hooks into the slot of the bracket. Use M4×14 stainless steel screws at holes E and F (in Figure 4.) to secure the mounting hooks to the rear of the inverter.

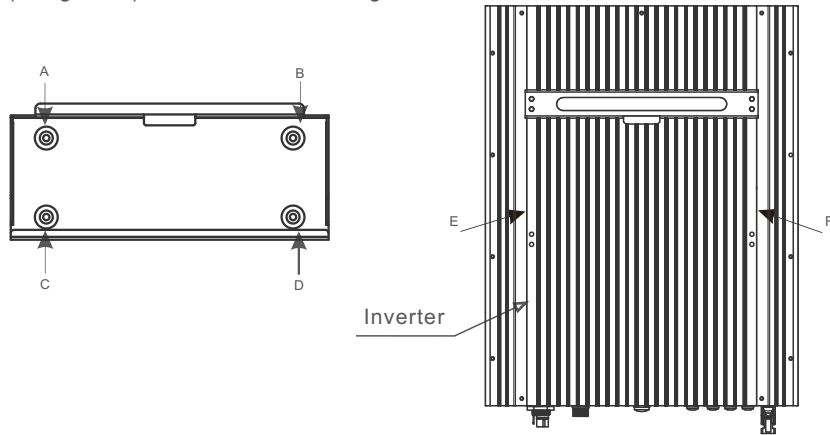

▲ Figure 4.4 Wall Mount Bracket

4.3 Electrical Connections

The Inverter is designed for electrical connection without removing the cover. The meaning of the symbols located at the bottom of the inverter are listed in Table 4.1. All electrical installations must be in accordance with all local and national electrical codes .

+	Positive DC input terminal
-	Negative DC input terminal
DC 1	Positive or negative DC 1 input terminal
DC 2	Positive or negative DC 2 input terminal
DC SWITCH	Switch of DC input terminals(optional)
COM	Communication connection equipment terminal (Optional)
GRID	Grid wires connection equipment terminal

▲ Table 4.1 Terminals

4. Installation

The electrical connection of the inverter must follow the steps listed below:

- Switch the Grid Supply Main Switch (AC) OFF.
- Switch the DC Switch OFF.
- Assemble PV input connector of the Inverter.



Before connecting inverter, please make sure the PV array open circuit voltage is within the limit of the inverter

Maximum 1000Voc for
Solis-6K Solis-10K Solis-15K Solis-20K-HV
Maximum 600Voc for
Solis-6K-LV Solis-10K-LV



Please don't connect PV array positive or negative pole to the ground, it could cause serious damages to the inverter



Before connection, please make sure the polarity of the output voltage of PV array matches the “DC+” and “DC-” symbols.



▲ Figure 4.5 DC+ Connector



▲ Figure 4.6 DC- Connector



Please use qualified DC cable for PV system.

4. Installation

The steps to assemble the DC connectors are listed as follows:

i) Strip off the DC wire for about 7mm, Disassemble the connector cap nut (see Figure 4.7).

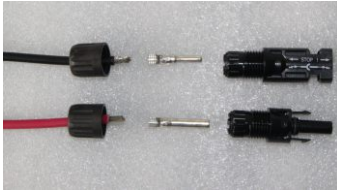

▲ Figure 4.7 Disassemble the Connector Cap nut

ii) Insert the wire into the connector cap nut and contact pin as shown in Figure 4.8.

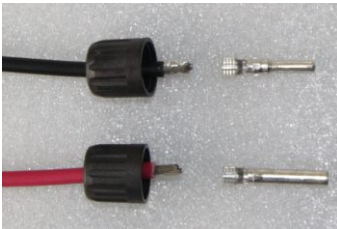

▲ Figure 4.8 Insert the Wire into the Connector Cap nut and contact pin

iii) Crimp the contact pin to the wire using a proper wire crimper as shown in Figure 4.9

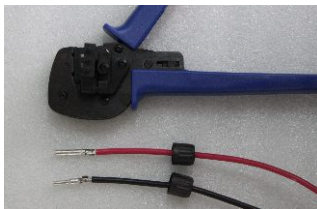

▲ Figure 4.9 Crimp the contact pin to the wire

iv) Insert the contact pin to the top part of the connector and screw up the cap nut to the top part of the connector (as shown in Figure 4.10).



▲ Figure 4.10 Connector with Cap nut Screwed on

v) Then connect the DC connectors to the inverter. Small click will confirm connection (as shown in Figure 4.11).

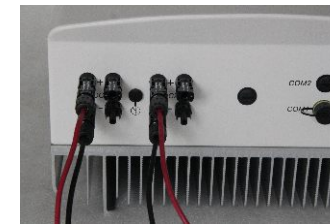

▲ Figure 4.11 Connect the DC Connectors to the Inverter

4. Assemble the grid side connector of the Inverter.

For all AC connections, 2.5-6mm² 105 °C cable is required to be used. Please make sure the resistance of cable is lower than 1.5 ohm. If the wire is longer than 20m, it's recommended to use 6mm² cable.



WARNING:

There are "L" "1" "2" "N" "⊥" symbols marked inside the connector (see Figure4.12), the Line wire of grid must be connected to "L" "1" "2" terminal; the Earth wire of grid must be connected to "⊥" ; it is recommended that the Neutral wire of grid is connected to "N" terminal (not required)

4. Installation

Each Solis three phase inverter is supplied with an AC grid terminal connector, which is in Figure 4.12.



▲ Figure 4.12 AC Grid Terminal Connector

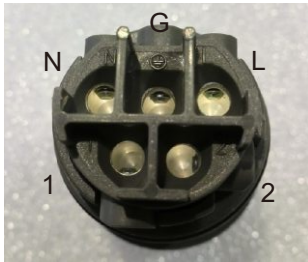

▲ Figure 4.13 AC Grid Terminal Connector Inside

The steps to assemble the AC grid terminal connectors are listed as follows:

- a) Strip the end of AC wire about 8mm, Insert the cable through the jacket and cap nut of connector, then insert the wires to the grid terminal and tighten the screws on the connector (as shown in Figure 4.13). Please try to pull out the wire to make sure it is well connected.

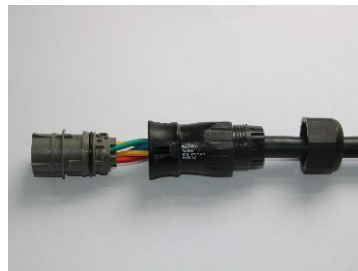
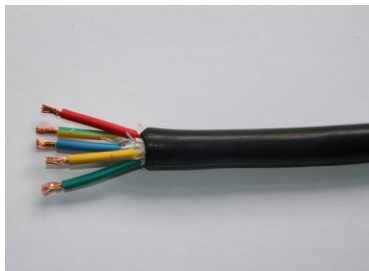

▲ Figure 4.14 Connect Wires to the Grid Terminal

4. Installation

- b) Assemble the connector and tighten up cap on the terminal (as shown in Figure 4.14).



▲ Figure 4.15 Tighten up the cap on the terminal

- c) Connect the AC grid terminal connector to the inverter. Small click will confirm connection (as shown in Figure 4.16).

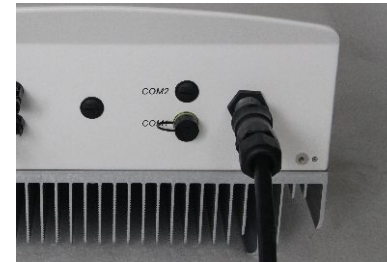

▲ Figure 4.16 Connect AC Terminal Connector to the inverter

4. Installation

5. Inverter monitoring Connection.

The inverter can be monitored by Wi-Fi or GPRS functions. All the communication functions are optional (Figure 4.17), please refer to communication connection instructions.

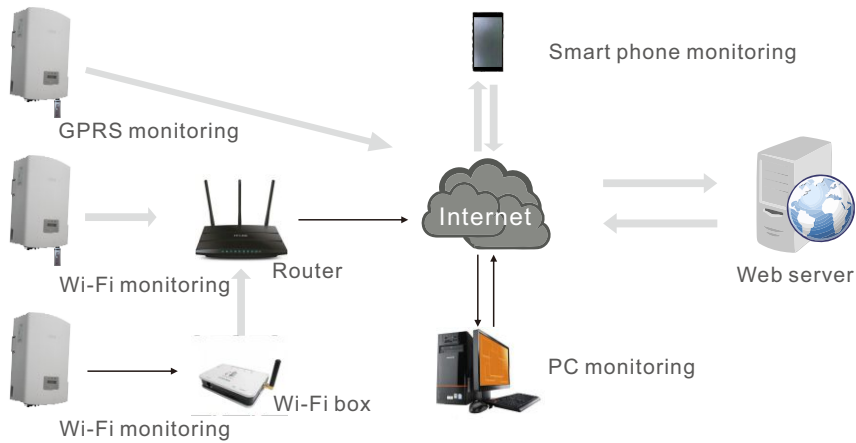

▲ Figure 4.17 Wi-Fi communication function

5. Start & Stop

5.1 Start the Inverter

To start up the Inverter, it is important that the following steps are strictly followed:

1. Switch the Supply Main Switch (AC) ON first.
2. Switch the DC Isolator ON. If the voltage of PV arrays are higher than start up voltage, the inverter will turn on. The red LED power will light, and the LCD shows the company's name and the inverter model.

Ginlong
Solis-15K

▲ Figure 5.1 Company Name and Inverter Model on LCD

3. When both the DC and the AC grid sides supply to the inverter, it will be ready to generate power. Initially, the inverter will check both its internal parameters and the parameters of the AC grid, to ensure that they are within the acceptable limits. At the same time, the green LED will flash and the LCD displays the information of INITIALIZING.
4. After 30-180 seconds (depending on local requirement), the inverter will start to generate power. The green LED will be on continually and the LCD displays GENERATING.



WARNING:

Do not touch the surface when the inverter is operating. It may be hot and cause burns.

5.2 Stop the Inverter

To stop the Inverter, the following steps must be strictly followed:

1. Switch the Grid Supply Main Switch (AC) OFF.
2. Wait 30 seconds. Switch off the DC switch or pull out the DC input cable. All the LEDs of the inverter will be off in a minute.

6. Operation

During normal operation, the display shows the power and the operation status alternately with each screen lasting for 10 seconds (see Figure 6.1). Screens can also be scrolled manually by pressing the UP and DOWN keys. Pressing the ENTER key gives access to Main Menu.

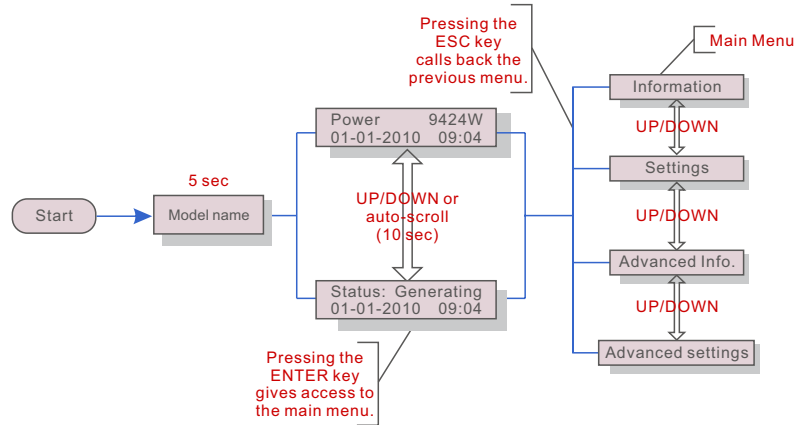

▲ Figure 6.1 Operation Overview

6.1 Main Menu

There are four submenus in the Main Menu (see Figure 6.1):

1. Information
2. Settings
3. Advanced Info.
4. Advanced Settings

6.2 Information

The Solis three phase PV inverter main menu provides access to operational data and information. The information is displayed by selecting "Information" from the menu and then by scrolling up or down.

6. Operation

Display	Duration	Description
V_DC1 350.8V I_DC1 5.1A	10 sec	V_DC1: Shows input 01 voltage value. I_DC1: Shows input 01 current value.
V_DC2 350.8V I_DC2 5.1A	10 sec	V_DC2: Shows input 02 voltage value. I_DC2: Shows input 02 current value.
V_Grid 400.4V I_Grid 8.1A	10 sec	V_Grid: Shows grid voltage value. I_Grid: Shows grid current value.
Status: generating Power: 1488W	10 sec	Status: Shows status of the inverter. Power: Shows output power value.
Grid Frequency F_Grid 50.06Hz	10 sec	F_Grid: Shows frequency of grid value.
Total Energy 0258458 kwh	10 sec	Total energy output value (since the last time energy was cleared).
This Month: 0123kwh Last Month: 0123kwh	10 sec	This Month: Total energy generated this month. Last Month: Total energy generated last month.
Today: 02kwh Yesterday: 01kwh	10 sec	Today: Total energy generated during this Day. Yesterday: Total energy generated last Day.

▲ Table 6.1 Information Indicator

Pressing the ESC key returns to the Main Menu. Pressing the ENTER key to lock (Figure 6.2(a)) or unlock (Figure 6.2 (b)) the screen.



(a)



(b)

▲ Figure 6.2 Lock and Unlock the Screen of LCD

6. Operation

6. Operation

6.3 Settings

The following submenus are displayed when the Settings menu is selected:

- 1.Set Time
- 2.Set Address

6.3.1 Setting Time

This function allows time and date setting. When this function is selected, the LCD will display a screen as shown in Figure 6.3.



```
NEXT=<ENT> OK=<ESC>
01-01-2010 16:37
```

▲ Figure 6.3 Set Time

Press the UP/DOWN keys to set time and data. Press the ENTER key to move from one digit to the next (from left to right). Press the ESC key to save the settings and return to the previous menu.

6.3.2 Setting Address

This function is used to set the address of an inverter connected to PC for communication purpose. The address number can be assigned from “01” to “99” (see Figure 6.4). The default address number of Solis three phase inverter is “01” .



```
YES=<ENT> NO=<ESC>
Set Address: 02
```

▲ Figure 6.4 Set Address

Press the UP/DOWN keys to set the address. Press the ENTER key to save the settings. Press the ESC key to cancel the change and return to the previous menu.

6.4 Advanced Info - Technicians Only



NOTE:

To access to this area is for fully qualified and accredited technicians only.

Select “Advanced Info.” from the Main Menu to display a screen and be able to access to the following information.

- 1.Alarm Message
- 2.Temperature
- 3.Standard No.
- 4.Version
- 5.Communication Data

The screen can be scrolled manually by pressing the UP/DOWN keys. Pressing the ENTER key gives access to a submenu. Press the ESC key to return to the Main Menu.

6.4.1 Alarm Message

The display shows the 10 latest alarm messages (see Figure 6.5). Screens can be scrolled manually by pressing the UP/ DOWN keys. Press the ESC key to return to the previous menu.

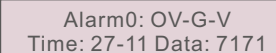

```
Alarm0: OV-G-V
Time: 27-11 Data: 7171
```

▲ Figure 6.5 Alarm Message

6.4.2 Temperature

The screen shows the temperature inside the inverter (see Figure 6.6).



```
Temperature
046.6°C
```

▲ Figure 6.6 Temperature inside the Inverter

6. Operation

6. Operation

6.4.3 Standard No.

The screen shows the reference standard of the Inverter (see Figure 6.7).

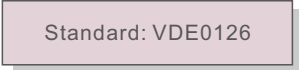

Standard: VDE0126

▲ Figure 6.7 Example of Standard of the Inverter

6.4.4 Version

The screen shows the model version and the software version of the Inverter (see Figure 6.8).



Model: 08
Software Version: D20001

▲ Figure 6.8 Model Version and Software Version

6.4.5 Communication Data

The screen shows the internal data of the Inverter (see Figure 6.13), which is for service technicians only.

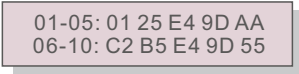

01-05: 01 25 E4 9D AA
06-10: C2 B5 E4 9D 55

▲ Figure 6.9 Communication Data

6.5 Advanced Settings - Technicians Only



NOTE:

To access to this area is for fully qualified and accredited technicians only. For technicians only.

Select Advanced Settings from the Main Menu to access the following options:

1. Select Standard
2. Grid ON/OFF
3. Calibrate Energy

6.5.1 Selecting Standard



NOTE:

The inverter is customized according to the local standard before shipping to the customer. The " User-Def" function can be only used by the service engineer and must to be allowed by the local energy supplier.



NOTE:

Before to using this function, please set "GRID OFF" to stop inverter (refer to Section 6.5.2).



NOTE:

This function is for technicians use only.

This function is used to select the grid's reference standard (see Figure 6.10).



YES=<ENT> NO=<ESC>
Standard: G59/3

▲ Figure 6.10

Press the UP/DOWN keys to select the standard (AS4777, AS4777_NQ, AUS-Q-0.9, AUS-Q-0.8, VDE4105, VDE0126, UL-240V, UL-208V, MEX-CFE, G83/2, G59/3, EN50438 DK, EN50438 IE, EN50438 NL, EN50438L, EN50438T and "User-Def" function).

Press the ENTER key to confirm the setting. Press the ESC key to cancel changes and returns to previous menu.

Selecting the User-Def sub menu will access to the following submenu (see Figure 6.11): Below is the setting range for User-Def. Use this function can change the limits manually.

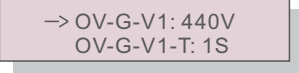

→ OV-G-V1: 440V
OV-G-V1-T: 1S

▲ Figure 6.11



IMPORTANT NOTE for installation in Australia:

The standard AUS-Q-0.9 and AUS-Q-0.8 mean fixed the inverter output power factor to 0.9 and 0.8. They are for Australia Energex and Ergon standard, please make sure the setting is suitable for local requirement. Otherwise it could reduce the power generated.

The default setting for Australia is standard AS4777.

6. Operation

Below is the voltage and frequency protection limits range for Solis three phase PV inverter:

For Solis-6K/Solis-10K/Solis-15K/Solis-20K-HV

OV-G-V1: 410---530V	OV-G-F1: 50.2-53Hz(60.2-63Hz)
OV-G-V1-T: 0.1---9S	OV-G-F1-T: 0.1---9S
OV-G-V2: 430---580V	OV-G-F2: 51-53Hz(61-63Hz)
OV-G-V2-T: 0.1---1S	OV-G-F2-T: 0.1---9S
UN-G-V1: 300---360V	UN-G-F1: 47-49.5Hz(57-59.5Hz)
UN-G-V1-T: 0.1---9S	UN-G-F1-T: 0.1---9S
UN-G-V2: 230---330V	UN-G-F2: 47-49Hz(57-59Hz)
UN-G-V2-T: 0.1---1S	UN-G-F2-T: 0.1---9S

For Solis-6K-LV/Solis-10K-LV

OV-G-V1: 220---288V	OV-G-F1: 50.2-53Hz(60.2-63Hz)
OV-G-V1-T: 0.1---9S	OV-G-F1-T: 0.1-9S
OV-G-V2: 220---288V	OV-G-F2: 51-53Hz(61-63Hz)
OV-G-V2-T: 0.1---1S	OV-G-F2-T: 0.1-9S
UN-G-V1: 160---210V	UN-G-F1: 47-49.5Hz(57-59.5Hz)
UN-G-V1-T: 0.1---9S	UN-G-F1-T: 0.1-9S
UN-G-V2: 160---210V	UN-G-F2: 47-49Hz(57-59Hz)
UN-G-V2-T: 0.1---1S	UN-G-F2-T: 0.1-9S



NOTE:

There are two stage for voltage and frequency limits in User-Def, please make sure limit 1 is in the scope of limit 2, otherwise the set will be failed. The initial values of the User-Def standard are some reference values. They are not indicating the values of the standard you are currently using.

Press the UP/DOWN keys to scroll through items. Press the ENTER key to edit the highlighted item. Press the UP/DOWN keys again to change the setting. Press the ENTER key to save the setting. Press the ESC key to cancel the change and return to the previous menu.



NOTE:

It must set Grid ON (refer to Section 6.5.2) before the new standard can be used.

6. Operation

6.5.2 Grid ON/OFF

This function is used to start or stop the generation of Solis three phase inverter (see Figure 6.12).



▲ Figure 6.12 Set Grid ON/OFF

Screens can be scrolled manually by pressing the UP/DOWN keys. Press the ENTER key to execute the setting. Press the ESC key to return to the previous menu.

6.5.3 Calibrate Energy

Maintenance or replacement could clear or cause a different value of total energy. Use this function could allow user to revise the value of total energy to the same value as before. If the monitoring website is used the data will be synchronous with this setting automatically. (see Figure 6.13).

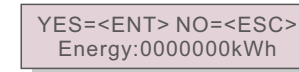

▲ Figure 6.13 Calibrate energy

Press the DOWN key to move the cursor, Press the UP key to revise the value. Press the ENTER key to execute the setting. Press the ESC key to return to the previous menu.

7. Maintenance

Solis three phase inverter does not require any regular maintenance. However, clean the heat-sink will help inverter dissipating heat and increase the life time of inverter.

The dirt on the inverter can be cleaned with a soft brush.



CAUTION:

Do not touch the surface when the inverter is operating. Some parts may be hot and cause burns. Turn OFF your inverter (refer to Section 5.2) and let it cool down before you do any maintenance or cleaning of inverter.

The LCD and the LED status indicator lights can be cleaned with cloth if they are too dirty to be read.



NOTE:

Never use any solvents, abrasives or corrosive materials to clean the inverter.

8. Trouble Shooting

The inverter is designed in accordance with the most important international grid-tied standards and safety and electromagnetic compatibility requirements. Before delivering to the customer, the inverter has been subjected to several tests to ensure its optimal operation and reliability.

In case of failure, the LCD screen will display an alarm message. In this case, the inverter may stop feeding into the grid. The failure descriptions and their corresponding alarm messages are listed in Table 8.1:

8. Trouble Shooting

Alarm Message	Failure description
OV-G-V	Over grid voltage
UN-G-V	Under grid voltage
OV-G-F	Over grid frequency
UN-G-F	Under grid frequency
G-IMP	High grid impedance
NO-GRID	No grid voltage
OV-DC	Over DC voltage
OV-BUS	Over DC bus voltage
UN-BUS	Under DC bus voltage
GRID-INTF.	Grid interference
INI-FAULT	Initialization system fault
OV-TEM	Over Temperature
GROUND-FAULT	Ground fault
ILeak-FAULT	High Grid leakage current
Relay-FAULT	Relay check fault
DCinj-FAULT	High DC injection current

▲ Table 8.1 Fault message and description



NOTE:

If the inverter displays any alarm message as listed in Table 8.1; please turn off the inverter (refer to Section 5.2 to stop your inverter) and wait for 5 minutes before restarting it (refer to Section 5.1 to start your inverter). If the failure persists, please contact your local distributor or the service center. Please keep ready with you the following information before contacting us.

1. Serial number of the Inverter;
2. The distributor/dealer of the Inverter (if available);
3. Installation date.
4. The description of problem (i.e. the alarm message displayed on the LCD and the status of the LED status indicator lights. Other readings obtained from the Information submenu (refer to Section 6.2) will also be helpful.);
5. PV array's configuration (e.g. number of panels, capacity of panels, number of strings, etc.);
6. Your contact details.

9. Specifications

Model	Solis-6K	Solis-10K
The max DC input voltage	1000Vdc	
MPPT operation range	200~800Vdc	
The max dc input current	15+15Adc	18+18Adc
Number of MPPT/strings per MPPT	2/1	2/2
Rated output power	6kW	10kW
The max. transient power	6.6kW	11kW
Rated grid voltage	400Vac	
The grid voltage range	313~470Vac(adjustable)	
Operation phase	Three phase	
Rated grid output current	8.7Aac	14.5Aac
Output power factor	>0.99	
Grid current THD	<4%(Total THD)	
The dc injection current	<20mA	
Rated grid frequency	50/60Hz	
Max. Efficiency	>97.5%	
Protection	DC reverse-polarity protection; AC short circuit protection; islanding protection; temperature protection. Etc.	
Size(mm)	430W*600H*220Dmm	
Weight	27kg	
Topology	Transformerless	
Internal consumption	<6W(Night)	
Running temperature	-25~60℃	
Ingress protection	IP65	
Interface	Rs485 WIFI GPRS(Optional)	
Design lifetime	>20years	
Operating Range Utility Frequency	47-52 or 57-62Hz(adjustable)	
Utility Monitoring	Islanding protection $V_{AC} F_{AC}$ in accordance with UL 1741, G59/3, AS4777, VDE 0126-1-1, VDE 4105, CEI 0-21, CQC	
Operation Surroundings Humidity	0~95%	
EMC	EN61000-6-1:2007 EN61000-6-3:2007	

9. Specifications

Model	Solis-15K	Solis-20K-HV
The max DC input voltage	1000Vdc	
MPPT operation range	200~800Vdc	
The max dc input current	18+18Adc	
Number of MPPT/strings per MPPT	2/2	
Rated output power	15kW	20kW
The max. transient power	15kW	20kW
Rated grid voltage	400Vac	480Vac
The grid voltage range	313~470Vac(adjustable)	427~523Vac(adjustable)
Operation phase	Three phase	
Rated grid output current	21.7Aac	24Aac
Output power factor	>0.99	
Grid current THD	<4%(Total THD)	
The dc injection current	<20mA	
Rated grid frequency	50/60Hz	
Max. Efficiency	>97.5%	
Protection	DC reverse-polarity protection; AC short circuit protection; islanding protection; temperature protection. Etc.	
Size(mm)	430W*600H*220Dmm	
Weight	30kg	
Topology	Transformerless	
Internal consumption	<6W(Night)	
Running temperature	-25~60℃	
Ingress protection	IP65	
Interface	RS485 WIFI GPRS(Optional)	
Design lifetime	>20years	
Operating Range Utility Frequency	47-52 or 57-62Hz(adjustable)	
Utility Monitoring	Islanding protection $V_{AC} F_{AC}$ in accordance with UL 1741, G59/3, AS4777, VDE 0126-1-1, VDE 4105, CEI 0-21, CQC	
Operation Surroundings Humidity	0~95%	
EMC	EN61000-6-1:2007 EN61000-6-3:2007	

9. Specifications

Model	Solis-6K-LV	Solis-10K-LV
The max DC input voltage	600Vdc	
MPPT operation range	150~500Vdc	
The max dc input current	15+15Adc	18+18Adc
Number of MPPT/strings per MPPT	2/2	
Rated output power	6kW	10kW
The transient max power	6.6kW	10kW
Rated grid voltage	208/220/240Vac	
The grid voltage range	180~270Vac(adjustable)	
Operation phase	Three phase	
Rating grid output current	16.6/15.7/14.4Aac	25/25/24Aac
Output power factor	>0.99	
Grid current THD	<4%(Total THD)	
The dc injection current	<20mA	
Rated grid frequency	50/60Hz	
Max. Efficiency	>97.2%	
Protection	DC reverse-polarity protection; AC short circuit protection; islanding protection; temperature protection. Etc.	
Size(mm)	430W*600H*220Dmm	
Weight	27kG	
Topology	Transformerless	
Internal consumption	<6W(Night)	
Running temperature	-25~60°C	
Ingress protection	IP65	
Interface	RS485 WIFI GPRS(Optional)	
Design lifetime	>20years	
Operating Range Utility Frequency	47-52 or 57-62Hz(adjustable)	
Utility Monitoring	Islanding protection $V_{AC} F_{AC}$ in accordance with UL 1741, G59/3, AS4777, VDE 0126-1-1, VDE 4105, CEI 0-21, CQC	
Operation Surroundings Humidity	0~95%	
EMC	EN61000-6-1:2007 EN61000-6-3:2007	